

Mindestmaße C-Steckklappe

C-Steckklappe
Drei-/Vierkant
M 1:5

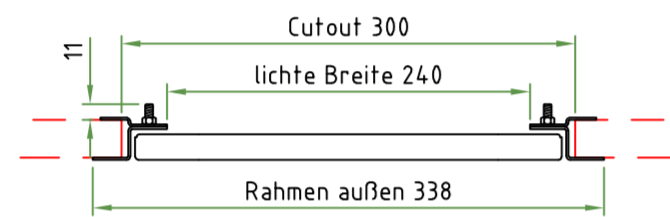

C-Steckklappe - ab 600mm Breite mit 2 Vorreibern
Drei-/Vierkant
M 1:5

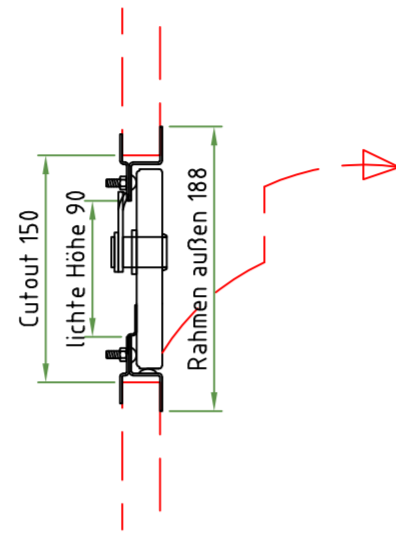
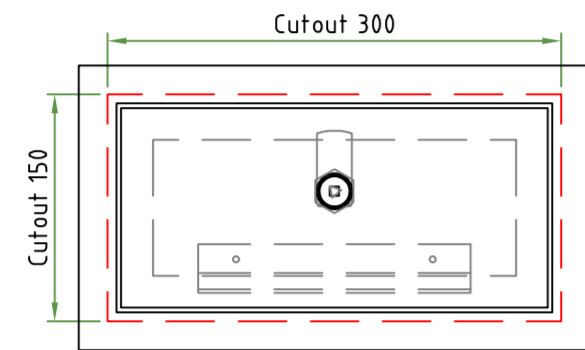
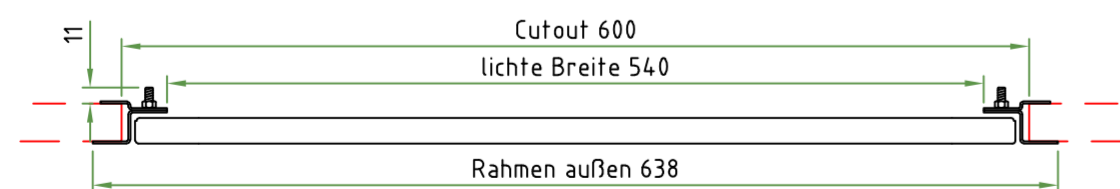
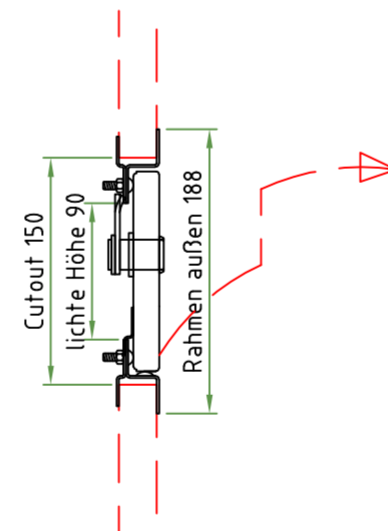
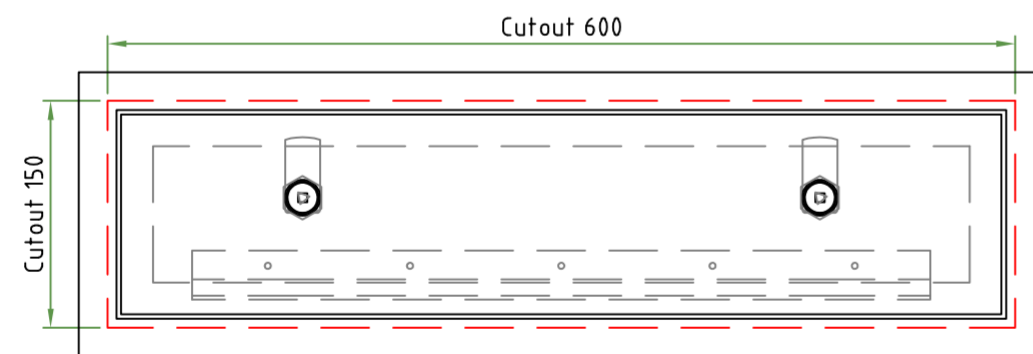

Detail Wandstärken

M 1:2

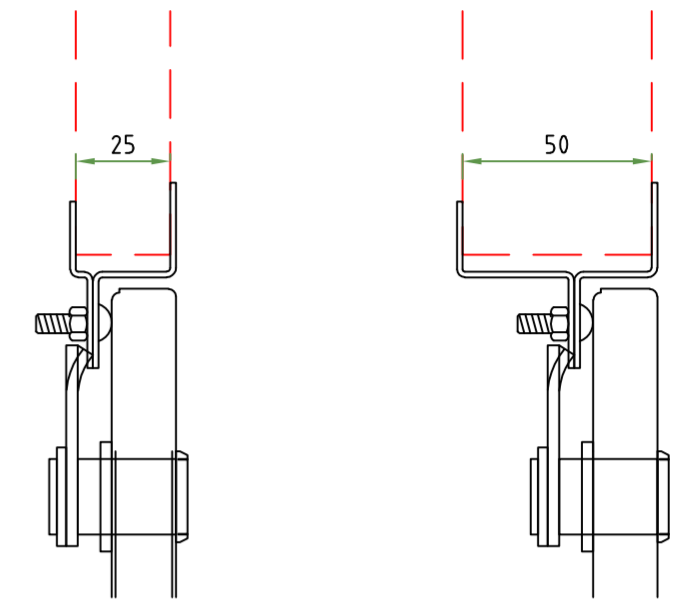

wichtig: die Steckklappen stehen immer auf dem Z-Profil!

CAD-System:		Tolerance		Scale 1:5		Weight	
				Name and No. of Typ			
08			Date	Name	Title Mindestmaße C-Steckklappe		
07			Draw	IH			
06			Checked	XXXXXX			
05			Stand	XXXXXX			
04							
03					Drawing No.		
02							
01							
Rev. No.	Revision	Date	Name	 interior outfitting insulation		Repl. for	Repl. by